

BF series 7-inch Intelligent central screen

Product Specifications



TDD GROUP LIMITED

Address: T2-B608, Shenzhen Software Park, No.22 Gaoxin South
7th Road, Nanshan District, Shenzhen 518057, China

Website: www.tddtouch.com

Note: The copyright of this document belongs to the original content company and all rights are reserved. If there are any modifications or updates to the document content, please contact the provider to obtain the latest version without further notice.

Contents

1 PRODUCT INTRODUCTION	1
1.1 APPEARANCE AND INTERFACE DIAGRAM	1
2 OVERALL SIZE	3
3 PRODUCT PARAMETERS.....	4
3.1 LCD AND TOUCH PARAMETERS	4
3.2 CORE PARAMETERS	4
3.3 OPERATION SYSTEM	5
3.4 ENVIRONMENTAL PARAMETERS.....	5
4 HARDWARE INTERFACE DESCRIPTION	7
4.1 SERIAL PORT	7
4.2 DC POWER CONNECTION.....	9
4.3 USB INTERFACE.....	9
4.4 KIO INTERFACE.....	10
4.5 AUDIO PORT	10
4.6 ETHERNET INTERFACE	11
4.7 WIFI MODULE.....	11
4.8 4G MODULE	11
4.9 GPS NAVIGATION	12
4.10 TF CARD SOCKET.....	12
4.11 MICRO-SIM CARD HOLDER	12
4.12 LED INTERFACE	12
4.13 USER BUTTONS.....	12
4.14 GROUND SCREWS.....	13
5 PRODUCT DEFINITION.....	14
5.1 NAMING RULES	14
5.2 PRODUCT MODEL.....	14
6 PACKAGING AND PHYSICAL DIMENSIONS.....	15
7 SAFETY PRECAUTIONS.....	16
8 WARRANTY AGREEMENT AND WARRANTY CARD	19

Revision Record

Version	Date	Describe	Editor
V1.0	2024-07-19	create documents	Xu Gan

1 Product Introduction

The BF series 7-inch smart central control screen products are equipped with mainstream Android 7.1 or above operating systems, which have the characteristics of higher main frequency, lower memory usage, and higher operating efficiency. The product is equipped with a 7-inch full view LCD screen, 5-point anti-interference capacitive touch, anti-static ESD level 3, pulse group EFT level 3, and surge level 3. The whole machine is fully enclosed in design, with dust-proof and waterproof touch surfaces. The structural space is small, and the installation is simple. It is suitable for flat installation and can meet the needs of indoor and semi outdoor environments.

1.1 Appearance and Interface Diagram



Front view

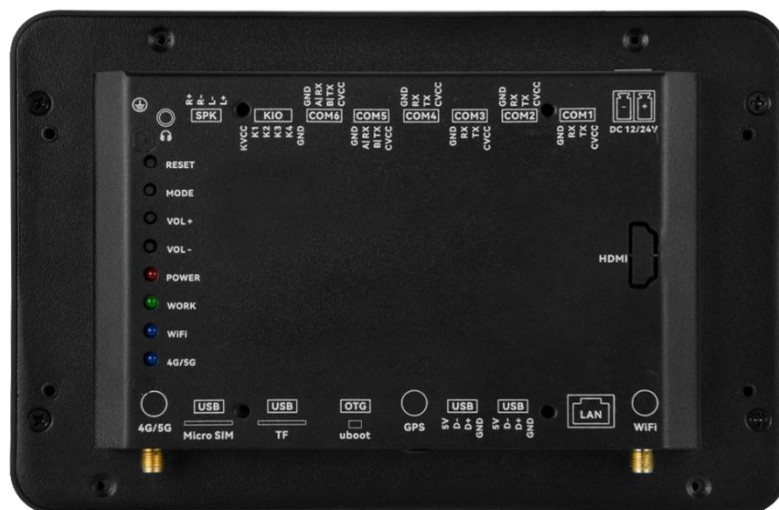

Rear view

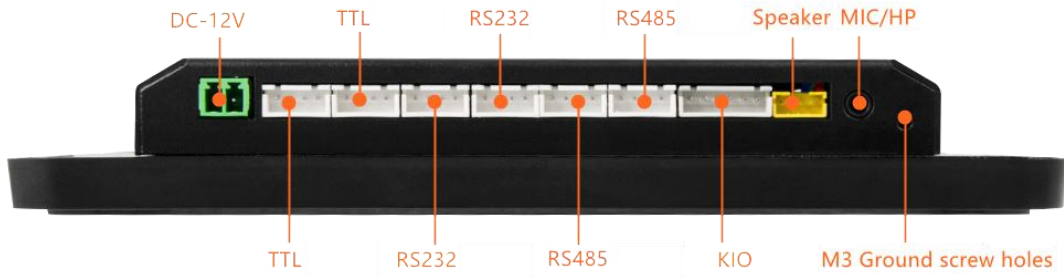

Front view

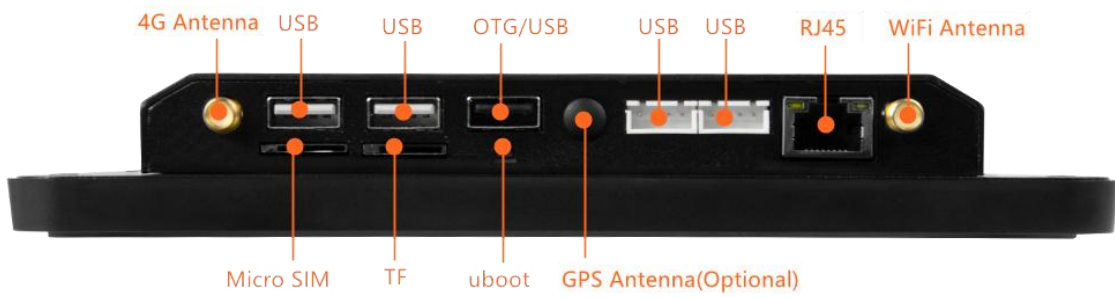

Rear view

2 Overall size

The dimensional drawing of the product is as shown below (unit: mm).

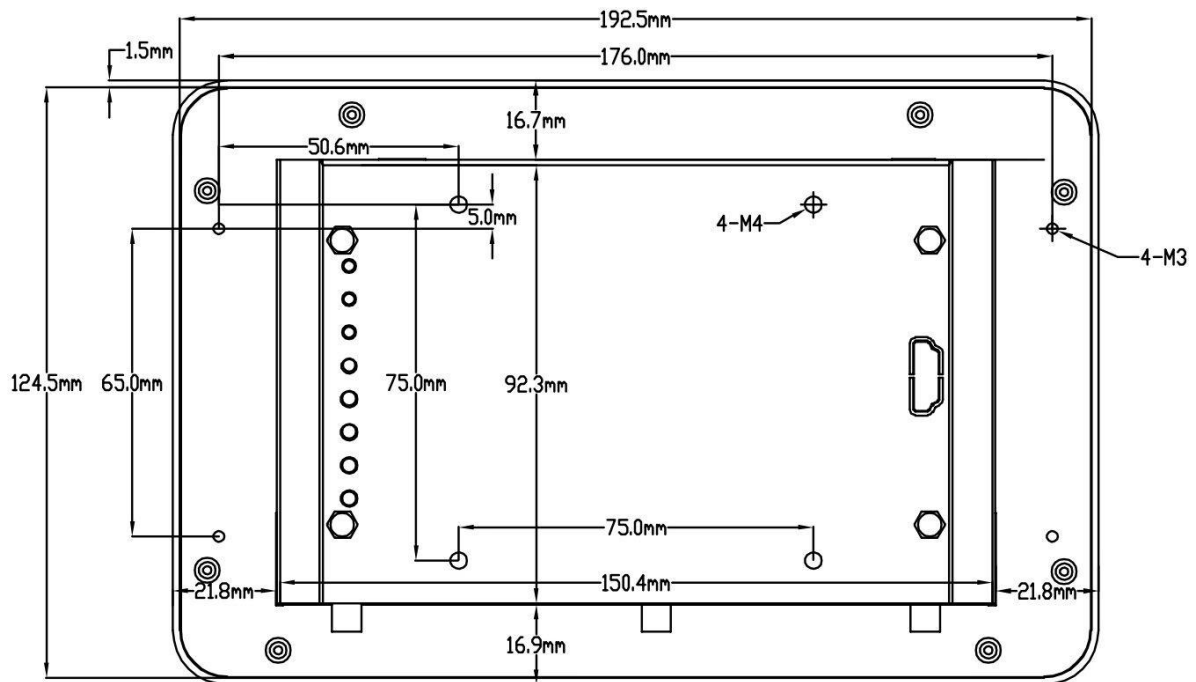
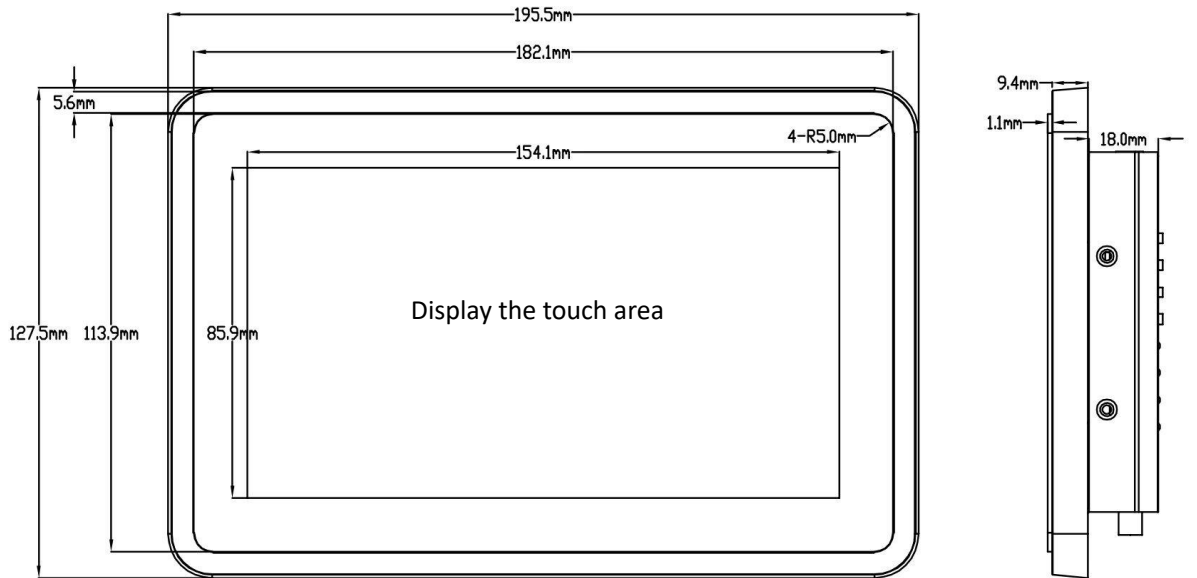

Model number	Overall dimensionW x H x D (unit: mm)	Mounting dimensionA x B (unit: mm)	Opening size(unit: mm)	
			A+2	B+2
BF series 7 "center control screen	195.5 x 127.5 x 28.5	182.1 x 113.9	184.1	115.9

3 Product parameters

3.1 LCD and touch parameters

Specifications	7 Inch, with touch		
Product model	TDD-CP-SCCS70BF-IC-A13 3P	TDD-CP-SCCS70BF-IC-RK328 8	TDD-CP-SCCS70BF-IC-RK356 8
resolution	1024*600	1024*600	1024*600
display scale	16:9	16:9	16:9
Display area	154.1*85.9mm	154.1*85.9mm	154.1*85.9mm
panel type	IPS	IPS	IPS
visual angle	Full perspective	Full perspective	Full perspective
brightness	500 cd/m ²	500 cd/m ²	500 cd/m ²
Touch screen type	capacitance	capacitance	capacitance
Touch mode	5-point touch	5-point touch	5-point touch
Glass thickness	1.8mm	1.8mm	1.8mm
Transmittance of glass	85%	85%	85%
Touch surface material	Flat tempered glass	Flat tempered glass	Flat tempered glass
Panel protection class	Front panel IP65, rear cover IP20	Front panel IP65, rear cover IP20	Front panel IP65, rear cover IP20
Overall dimensions	195.5*127.5mm	195.5*127.5mm	195.5*127.5mm

Specifications	7 Inch, no touch		
Product model	TDD-CP-SCCS70BF-IN-A13 3P	TDD-CP-SCCS70BF-IN-RK32 88	TDD-CP-SCCS70BF-IN-RK35 68
resolution	1024*600	1024*600	1024*600
display scale	16:9	16:9	16:9
Display area	154.1*85.9mm	154.1*85.9mm	154.1*85.9mm
panel type	IPS	IPS	IPS
visual angle	Full perspective	Full perspective	Full perspective
brightness	500 cd/m ²	500 cd/m ²	500 cd/m ²
Touch screen type	NO	NO	NO
Touch mode	NO	NO	NO
Glass thickness	1.8mm	1.8mm	1.8mm
Transmittance of glass	85%	85%	85%
Touch surface material	Flat tempered glass	Flat tempered glass	Flat tempered glass
Panel protection class	Front panel IP65, rear cover IP20	Front panel IP65, rear cover IP20	Front panel IP65, rear cover IP20
Overall dimensions	195.5*127.5mm	195.5*127.5mm	195.5*127.5mm

3.2 Core parameters

Program	Allwinner A133P	Rockchip RK3288	RockchipRK3568
CPU	4-Core A53, Clockd at 1.8GHz	4-Core A17, Clockd at 1.8GHz	4-Core A55, Clockd at 2.0GHz

GPU	GE8300	Mali-T764	Mali-G52 2EE
Memory + Storage	1GB+8GB,2GB+16GB, 4GB+32GB	2GB+16GB, 4GB+32GB	2GB+16GB, 4GB+32GB, 8GB+64GB
HDMI	NO	HDMI 2.0	HDMI 2.0
Ethernet	100Mbps	Gigabit	Gigabit
COM	Support (optional, choose between COM and Uart6)	NO	NO
CAN	NO	NO	Support (optional, choose between CAN and COM6)
WiFi	Standard Single frequency WiFi6(Optional Dual-band WiFi6)		
Bluetooth	WiFi6 standard BT 5.2		
HP& MIC	1-way 4-segment integrated 3.5mm socket for earphones		
power amplifier	1 channel 8Ω· 6W dual audio amplifier output		
USB	2 USB socket, 2 USB hosts, 1 USB OTG socket		
Serial port	2-way TTL, 2-way RS232, 2-way RS485(Optional 6 TTL or 4 RS232)		
4G/5G(Optional)	EC800M/EC600/EC20,RG200U(5G)		
GPS(Optional)	EC800M,Supports dual positioning of Beidou and GPS		
SIM	1-way Micro SIM card slot		
TF	1-way self-ejecting TF card socket, up to 256GB TF card support		
GPIO	4-way GPIO signal		
LED	4-way, power light, running indicator light, WiFi indicator light, 4G/5G network indicator light		
User buttons	Reset key, return key, volume+and volume -, burn key		
Source	1 circuit, DC12V ± 5%/DC24V ± 5% power supply, DC 2P-3.81MM		

3.3 Operation System

Operating system	Allwinner A133P	Rockchip RK3288	RockchipRK3568
Android	Android 10	Android 7.1/5.1/6.0/8.1	Android 11/12
Linux	Ubuntu 18.04/Linux QT	Ubuntu-18.04/Debian9/Linux QT	Ubuntu-20.04/Debian 11/Linux QT
Domestic operating system	NO	NO	OpenHarmony 4.0,Tongxin UOS

3.4 Environmental parameters

work environment	
Rated power	4.5W
Working voltage	12~24V,Typical value 12V
Standby power consumption	0.42W
working temperature	-10°C ~ 60°C
Storage temperature	-20°C ~ 70°C
Working humidity	0% ~ 95%(No condensation)
Electrostatic discharge immunityESD	Level 3
Electrical fast transient pulse group immunity EFT	Level 3RS232、RS485、USB、Ethernet
Surge (impact) immunity SURGE	Level 3RS485、Ethernet、power
Immunity to conducted disturbances induced by radio frequency fields CS	Level 2power

Radiation electromagnetic disturbance (magnetic field emission) RE	Class B
Conducted disturbance test CE	Class B
Recommended working power supply: 12V 2A DC stabilized power supply	

4 Hardware Interface Description

4.1 Serial port

COBF~COM6 use XH2.54-4P white plug-in, CVCC power supply is 3.3V, with 2 TTL serial ports, 2 RS232 serial ports, and 2 RS485 serial ports. The total current cannot exceed 400mA.(Note: triangle is marked as 1 pin)

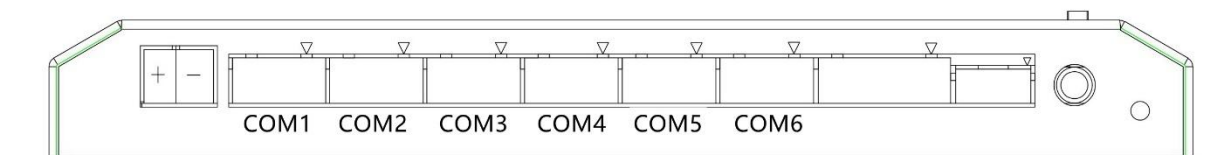

CPU	Serial port	Pin#	Definition	Device nodes	Default level	Optional level	Optional CAN	Optional COM
RK3288	COBF	1	GND	ttyS1	TTL	RS232	/	/
		2	RX					
		3	TX					
		4	CVCC					
	COM2	1	GND	ttyS2	TTL	RS232	/	/
		2	RX					
		3	TX					
		4	CVCC					
	COM3	1	GND	ttyS3	RS232	TTL	/	/
		2	RX					
		3	TX					
		4	CVCC					
	COM4	1	GND	ttyS4	RS232	TTL	/	/
		2	RX					
		3	TX					
		4	CVCC					
	COM5	1	GND	ttyS5	RS485	TTL	/	/
		2	RX					
		3	TX					
		4	CVCC					
COM6	1	GND	ttyS6	RS485	TTL	/	/	
	2	RX						
	3	TX						
	4	CVCC						
	COBF	1	GND	ttyS0	TTL	RS232	/	/
		2	RX					
		3	TX					
		4	CVCC					

	COM2	1	GND	ttyS2	TTL	RS232	/	/
		2	RX					
		3	TX					
		4	CVCC					
	COM3	1	GND	ttyS3	RS232	TTL	/	/
		2	RX					
		3	TX					
		4	CVCC					
	COM4	1	GND	ttyS4	RS232	TTL	/	/
		2	RX					
		3	TX					
		4	CVCC					
	COM5	1	GND	ttyS5	RS485	TTL	/	/
		2	RX					
		3	TX					
		4	CVCC					
COM6	1	GND	ttyS9	RS485	TTL	can0	/	
	2	A RX L						
	3	B TX H						
	4	GND						
A133P	COBF	1	GND	ttyS0	TTL	RS232	/	/
		2	RX					
		3	TX					
		4	CVCC					
	COM2	1	GND	ttyS2	TTL	RS232	/	/
		2	RX					
		3	TX					
		4	CVCC					
	COM3	1	GND	ttyS3	RS232	TTL	/	/
		2	RX					
		3	TX					
		4	CVCC					
	COM4	1	GND	ttyS4	RS232	TTL	/	/
		2	RX					
		3	TX					
		4	CVCC					
	COM5	1	GND	ttyS5	RS485	TTL	/	/
		2	RX					
		3	TX					
		4	CVCC					
	COM6	1	GND NO	ttyS6	RS485	TTL	/	NO, IO No.232
		2	A RX COM					COM
		3	B TX NC					NC, IO No.232

4.2 DC Power Connection

This product uses 12V ~ 24V DC power supply, connect the positive terminal of the external power supply to the '+' terminal, and the negative terminal of the power supply to the '-' terminal.

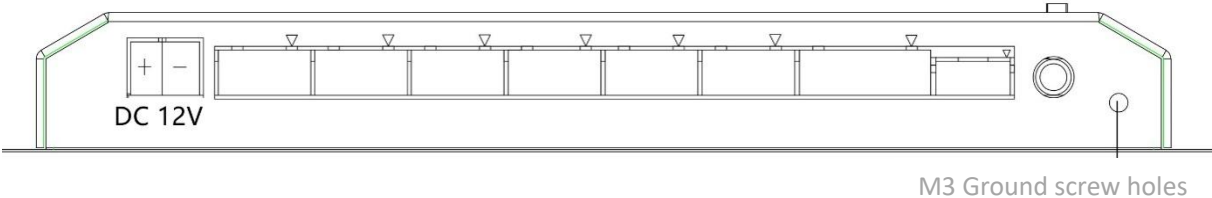

- Power requirements: This product can only use DC power supply (range 9V ~ 24V), the power supply can provide capacity is not less than the model specification requirements.
- The DC power supply must be correctly separated from the AC main power supply; Do not share power with inductive load circuits (such as solenoid valves) to avoid electromagnetic interference.
- Power supply power cables and communication cables should avoid strong interference cables such as AC power cables or motor drive cables and walk the lines, and keep at least 30cm away.
- The conductor of the grounding wire is directly connected to the system ground point, do not pass through the housing or terminal of other electrical equipment after grounding, which can ensure that the grounding conductor will not withstand the current of other branches, and ensure that the length of the grounding conductor is as short as possible.

4.3 USB interface

2-way USB-HOST, using a single-layer USB TYPEA socket. USB-HOST uses 5V output power supply, and the total current cannot exceed 1.5A.

One USB-OTG interface adopts Type A interface, which defaults to firmware burning port when powered on and can be connected to PC for software burning; After entering Android, you can set it as a USB ADB debugging port or a regular USB Host interface through the software.

2-way USB-HOST adopts XH2.54-4P white plug-in, USB-HOST uses 5V output power supply, and the total current cannot exceed 1.5A.(Note: triangle is marked as 1 pin)

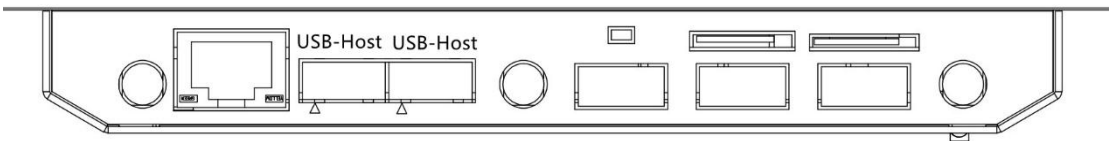

Pin#	Definition	Explanation
1	GND	Digital Ground

2	D+	USB Differential Data+
3	D-	USB Differential Data-
4	5V	5V output

4.4 KIO interface

4-way KIO uses XH2.54-4P gray connector, KVCC default 3.3V power supply, 3.3V level bidirectional IO; Optional:KVCC 5V power supply, 5V level bidirectional IO.(Note: KVCC do not connect 12V, triangle is marked as 1 pin)

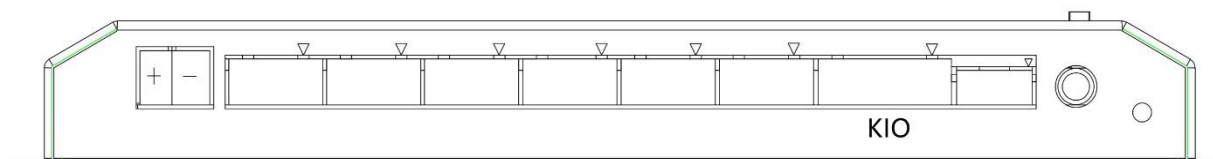

Chip	interface	Pin#	Definition	IO Number	IO level	Default level	input /Output
RK3288	KIO	1	KVCC	/	3.3V	3.3V	Output
		2	K1	218	3.3V	3.3V	Two-way
		3	K2	248	3.3V	3.3V	Two-way
		4	K3	249	3.3V	3.3V	Two-way
		5	K4	250	3.3V	3.3V	Two-way
		6	GND	/	/	/	/
RK3568	KIO	1	KVCC	/	3.3V	3.3V	Output
		2	K1	88	3.3V	3.3V	Two-way
		3	K2	89	3.3V	3.3V	Two-way
		4	K3	90	3.3V	3.3V	Two-way
		5	K4	91	3.3V	3.3V	Two-way
		6	GND	/	/	/	/
A133P	KIO	1	KVCC	/	3.3V	3.3V	Output
		2	K1	66	3.3V	3.3V	Two-way
		3	K2	67	3.3V	3.3V	Two-way
		4	K3	68	3.3V	3.3V	Two-way
		5	K4	71	3.3V	3.3V	Two-way
		6	GND	/	/	/	/

4.5 Audio port

HP/MIC is a four-segment 3.5mm headphone/microphone integrated socket (CTIA US standard definition - figure below) with mono MIC input + dual HP output.

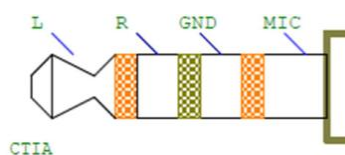

SPK is the speaker interface, using PH2.0-4P yellow connector, and the power amplifier circuit is two-channel 8Ω/6W. (Note: triangle is marked as 1 pin)

Port	Pin#	Definition	Explanation
Speaker	1	R+	Speaker right channel +
	2	R-	Speaker right channel -
	3	L-	Speaker left channel-
	4	L+	Speaker left channel+

4.6 Ethernet interface

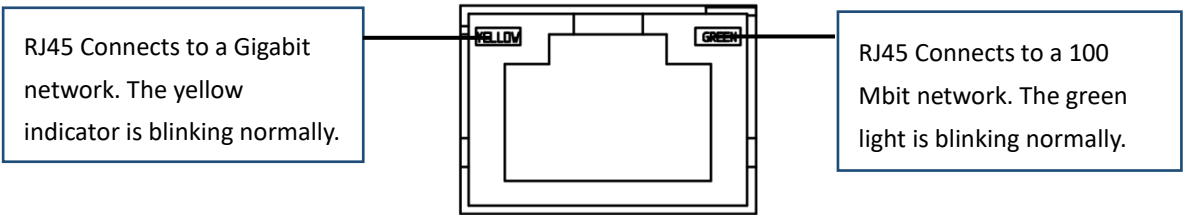

1 RJ45 Ethernet interface, the default IP is assigned by DHCP. If you need to manually configure the IP address, you can manually configure it in the advanced settings.

4.7 WiFi module

Standard: 2.4G WiFi, WiFi standard IEEE Std 802.11 b/g/n/ax

Optional 2.4G/5G WiFi, WiFi standard IEEE Std 802.11 a/b/g/n/ac/ax

4.8 4G module

Optional CAT1 4G module: MPCIE-4G-EC600 and MPCIE-4G-EC800 (with GPS)

Operator	Frequency band	Explanation
Mobile 4G	LTE-FDD: B1/3/5/8;	support
Unicom 4G	LTE-TDD: B34/38/39/40/41;	support
Telecom 4G	GNSS: GPS/BDS Beidou /GLONASS/Galileo (Optional)	support

Optional CAT4 4G module:EC20

Operator	Frequency band	Explanation
Mobile 2G/3G/4G	LTE FDD: B1/B3/B5/B8	support
	LTE TDD: B34/B38/B39/B40/B41	
Unicom2G/3G/4G	TD-SCDMA: B34/B39	support
	WCDMA: B1/B8	
Telecom2G/3G/4G	CDMA: BC0	support
	GSM: 900/1800 MHz	
	GNSS:GPS/GLONASS/BeiDou/Galileo/QZSS(Optional)	

4.9 GPS navigation

Optional 4G module with GPS function, equipped with a dedicated GPS active antenna and placed in an open outdoor location, supporting Beidou and GPS dual positioning.

4.10 TF card socket

Standard TF card socket, supports hot swap detection, supports TF cards with a maximum capacity of 256 GB.

4.11 Micro-SIM card holder

The SIM card holder is a conventional medium card slot. When inserting the card, please pay attention to inserting the SIM card with the notch facing outward;

Hot swapping is not supported and requires power off and restart.

4.12 LED interface

[POWER] Power lamp, the main board power supply is normal, the indicator light is on; The mainboard is powered off, and the indicators are off.

[WORK] Operation indicator, the system runs normally, the indicator is on; The power supply to the mainboard is unstable and the indicators are blinking.

[WIFI] WiFi indicator, after the motherboard is powered on, the system detects that the WiFi function is normal, and the indicator is steady on.

[4G/5G] Mobile network indicator, the internal 4G module is connected, the SIM card is inserted, and the mobile network is normal and the indicator is steady on after the motherboard is powered on.

4.13 User buttons

[RESET] Press the reset button once to restart the system.

[MODE] Press the HOME button once to return to the system desktop. (In Linux, the key mapping is changed to Enter.)

[U1/V+] User can customize programming. If you press the default volume button once, the multimedia volume of the system increases by 10%. (In Linux, the key mapping is changed to up.)

[U2/V-] User can customize programming. Default Volume reduction button. Press it once to reduce the multimedia volume by 10%. (In Linux, the key mapping is changed to downward.)

[uboot] System burning button, manually press and hold, and then power on about 3 seconds after the release of the button, then enter the burning mode.

4.14 Ground Screws

[Ground screw] M3 stainless steel round head screw (including gasket + flat washer), length 5mm.

5 Product definition

5.1 Naming rules

The model definition of the product is as follows.

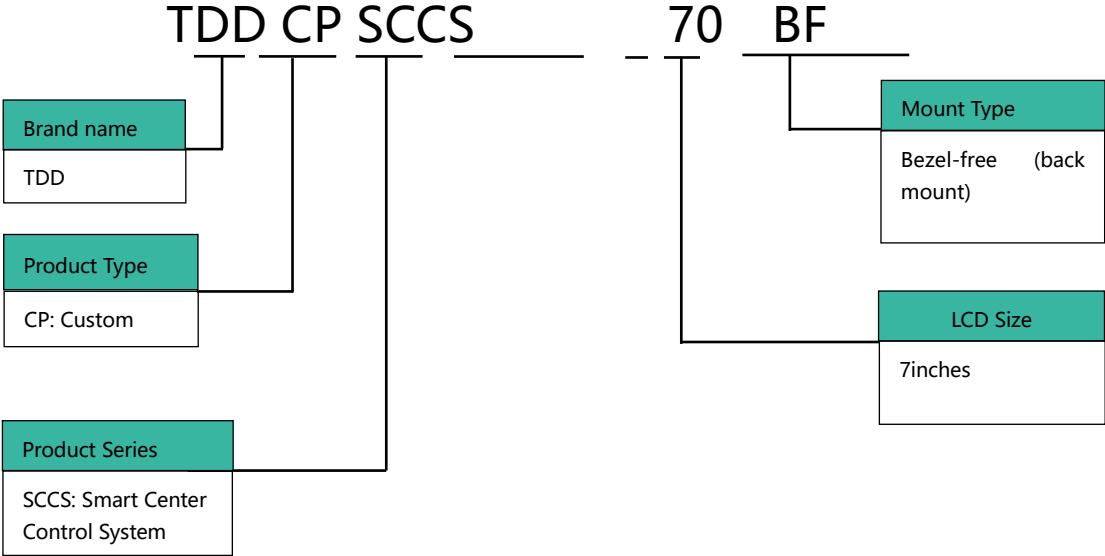

5.2 Product model

Product selection table

Product number	CPU	touch	HDMI	explanation
TDD-CP-SCCS70BF-IC-A133 P	A133P	Capacitive	NO	Optional 4G, GPS/WiFi 2.4&5G
TDD-CP-SCCS70BF-IN-A133 P	A133P	NO	NO	Optional 4G, GPS/WiFi 2.4&5G
TDD-CP-SCCS70BF-IC-RK32 88	RK3288	Capacitive	Support	Optional 4G, GPS/WiFi 2.4&5G
TDD-CP-SCCS70BF-IN-RK32 88	RK3288	NO	Support	Optional 4G, GPS/WiFi 2.4&5G
TDD-CP-SCCS70BF-IC-RK35 68	RK3568	Capacitive	Support	Optional 4G, GPS/WiFi 2.4&5G
TDD-CP-SCCS70BF-IN-RK35 68	RK3568	NO	Support	Optional 4G, GPS/WiFi 2.4&5G

6 Packaging and physical dimensions

Item weight				
Bare weight(kg)	0.7015			
Overall size	195.5mm x 127.5mm x 28.5mm			
Packing standard and total weight				
Box type	Packing box specifications (L * W * H, unit: mm)	Number of layers	Quantity	Total weight(kg)
7.0 "packing box	233*160*52	1	1	0.8215

Note: Total weight does not include weight of parts.

7 Safety Precautions

■ Safety statement



1. Read and follow these safety precautions when installing, operating, and maintaining the product.
2. When installing, operating, and maintaining the product, follow the labels on the product and all the safety precautions described in the manual.
3. The "Caution", "warning" and "danger" in the manual do not represent all safety matters that should be observed, but only serve as a supplement to all safety precautions.
4. This product should be used in an environment that meets the requirements of the design specifications, otherwise it may cause failure, and the abnormal function or component damage caused by failure to comply with the relevant regulations are not within the scope of product quality assurance.
5. Due to illegal operation of products caused by personal safety accidents, property losses, etc., our company will not assume any legal responsibility.

■ Safety class definition

 Risk : "Dangerous" means death or serious physical injury if not performed according to regulations.

 Warn : "Warning" means that failure to follow the rules may result in death or serious bodily injury.

 Note : "Caution" Failure to perform as required may result in minor physical injury or equipment damage. Please keep this guide safe and ready to read when needed, and be sure to give this manual to the end user.

Control system design	
 Risk	<ul style="list-style-type: none">● Interlock circuit and other circuits such as emergency stop, conventional protection and forward and reverse rotation shall be set outside this product; Devices used to prevent equipment damage (above, below and reciprocating movement limits) shall be installed outside the product;● A "fail-safe circuit" outside the product to prevent unsafe and unexpected mechanical movement (such as in the event of an error in an input/output control area that cannot be detected by the product);● Please be sure to design a user program to ensure the safety of the user system when the display, control, communication, power and other failures occur in this product;● Ensure that the communication failure between the product and its master controller will not cause abnormal equipment function, avoid personal injury or equipment damage;● Do not touch the metal shell of the product with charged objects during use
 Note	<ul style="list-style-type: none">● Do not design switches on the touch panel that may cause personal injury to the operator or damage to the equipment. Please design switches that perform important operations separately, otherwise wrong output or failure may

cause accidents;

- Do not create touch panel switches that control the safe operation of the device, such as emergency stop switches. Please set the hardware switch to perform this operation. Otherwise, serious personal injury or device damage may be caused.
- Do not use this product as a warning device that may cause serious personal injury, equipment damage or system shutdown. Use separate hardware and/or mechanical interlocks to design important alarm indications and their control/triggering devices.

Install



- Please install this product correctly, this product can be used indoors/outdoors, please ensure that the use environment meets the requirements of "Basic parameters: General specifications" below;
- Do not install in strong magnetic field, direct sunlight, high temperature, flammable gas, steam or dust, otherwise there is explosion risk;
- Do not use this product in an environment where the temperature may change drastically or the humidity is high, otherwise condensed water may be generated inside the equipment, resulting in equipment damage;
- Make sure all cable connectors are securely connected to the product. If the connection is loose, it may produce an incorrect input or output signal.



- Please install the product within the storage temperature range recommended in this manual. Otherwise, the LCD display may fail.

Wiring



- Installation, wiring and other operations, please be sure to cut off all power after; Do not connect or remove cables when they are live. Otherwise, electric shocks may occur or the circuit may be damaged.
- Please connect the wiring of the DC power supply to the special terminal as described in this manual;
- During screw hole processing and wiring, do not let metal chips or wire heads fall into the HMI interior to avoid failure, damage to electronic components or fire;
- After the wiring is completed, it should be carefully checked to ensure that the working voltage and the position of the terminal are correct. Otherwise, it may cause fire or accident.



- In order to avoid electric shock, please cut off the power supply before connecting the power supply of this product;
- The input power supply of this product is 12 ~24V. If the power supply is not within 12V~24V, it will seriously damage the product. Therefore, please regularly check whether the DC power supply provided by the switched power supply is stable.

Operation/maintenance



- In the process of use, pay attention to protect the screen panel, touch the hand operation, avoid using tools to touch the display panel, the user is responsible for the damage caused by excessive external force;
- Lithium batteries, LCD screens, capacitors, etc., may contain ingredients that harm health and pollute the environment. When the products are discarded, please treat them as industrial waste.

Security Advice

- Where the operator has direct contact with the mechanical part, such as the location of loading and unloading mechanical tools, or where the machine operates automatically, careful consideration must be given to the function of the field manual device or other standby means, which need to be independent of the programmable controller and can start or interrupt the automatic operation of the system;
- If the program needs to be modified while the system is in operation, consider locking or other protective measures to ensure that only authorized personnel can make the necessary changes.

Scrap**Note**

- Please treat as industrial waste; The disposal of batteries should be carried out separately according to the laws established by each region.

8 Warranty agreement and warranty card

- Warranty agreement

The warranty period of this product is twelve months (subject to the information of the body bar code). If there is a special agreement, the contract terms at the time of purchase shall prevail), the warranty period in accordance with the normal use of the manual, the product failure or damage, our company is responsible for free maintenance. During the warranty period, due to the following reasons for damage, a certain maintenance fee will be charged:

- Machine damage caused by errors in use and unauthorized disassembly, repair and transformation;
- Machine damage caused by fire, flood, abnormal voltage, other natural disasters and secondary disasters;
- Hardware damage caused by human falling and transportation after purchase;
- Machine damage caused by not operating according to the user manual provided by our company;
- Failure and damage caused by obstacles other than the machine (such as external equipment factors).

When the product fails or is damaged, please fill in the contents of the Product Warranty Card correctly and in detail.

The charge of maintenance fees shall be subject to the latest adjustment of our company's Maintenance Price List.

This warranty card will not be reissued under normal circumstances, please be sure to keep this card, and show it to the maintenance personnel during the warranty.

If there is any problem in the service process, please contact our agent or our company in time.

By purchasing this product, the customer agrees to this warranty agreement. The right of interpretation of this agreement belongs to TDD GROUP LIMITED.

- Product warranty card

- Notes for repair

- 1) Must write the reason and your company's information.
- 2) Unknown source express, can only be set aside, can not be processed.
- 3) Please do not send to pay, do not put in the nest express cabinet.
- 4) Please ensure that the package is in good condition to prevent damage during the logistics process.

- Repair receiving information

Company name: TDD GROUP LIMITED
Delivery address: T2-B608, Shenzhen Software Park, No.22 Gaoxin South 7th Road, Nanshan District,

Shenzhen 518057, China	
Sales Manager: Thomas Hou	Telephone: +86 15002067862

● Rework product registration

Product name (required)	Quantity (required)	Problem Description

● Customer information registration

Company name (required):	
Delivery address (required):	
Recipient (required):	Telephone: